

Stainless Steel Non-Return Valves

Stainless steel non-return valves are ideally suited to **harsh environments** and for conveying **many industrial fluids**. These products allow fluids to flow in one direction and prevent them from flowing in the other.

Product Advantages

Demanding Environments | Robust design
 Suitable for use with many chemicals or in corrosive environments
 Compatible with many fluids

Compact & Versatile | Reduced dimensions
 Smooth external surfaces contribute to equipment cleanliness
 Flow direction symbol protects against incorrect installation
 Hexagonal body to facilitate installation



Applications
 Pneumatics
 Machine Tools
 Food Process
 Printing
 Chemical
 Textile
 Automotive Process

Technical Characteristics

Compatible Fluids	Many fluids
Working Pressure	0.5 to 40 bar
Working Temperature	-20°C to +180°C

Flow Characteristics	Threads	NI/min	Kv
	G1/8	18.88	1.60
G1/4	19.91	1.69	
G3/8	35.54	3.01	
G1/2	36.50	3.10	
G3/4	65.86	5.59	
G1	92.60	7.86	

Cracking Pressure	0.25 bar
--------------------------	----------

Component Materials

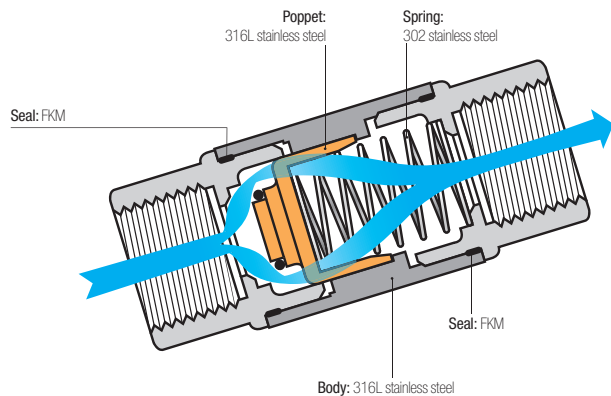



Silicone-free

Regulations

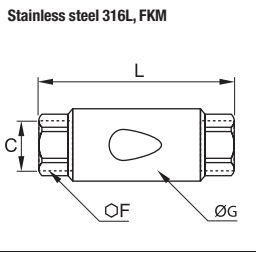

DI: 2002/95/EC (RoHS)
 RG: 1907/2006 (REACH)
 DI: 97/23/EC (PED)

Stainless Steel Non-Return Valves

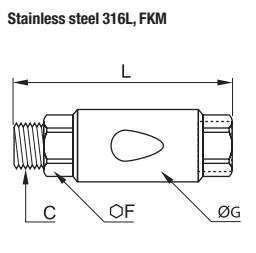

4890 Non-Return Valve, Female BSPP Thread

	Stainless steel 316L, FKM		C	DN		F	G	L	kg
			G1/8	10	4890 10 10	17	22	50	0.083
			G1/4	10	4890 13 13	17	22	50	0.074
			G3/8	15	4890 17 17	22	30	67	0.183
			G1/2	15	4890 21 21	24	30	71	0.209
			G3/4	20	4890 27 27	32	42	84	0.289
			G1	25	4890 34 34	38	42	90	0.519

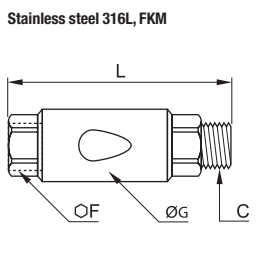

4891 Non-Return Valve, Supply, Male BSPP Thread/Exhaust, Female BSPP Thread

	Stainless steel 316L, FKM		C	DN		F	G	L	kg
			G1/8	10	4891 10 10	17	22	56	0.100
			G1/4	10	4891 13 13	17	22	58	0.082
			G3/8	15	4891 17 17	22	30	75	0.189
			G1/2	15	4891 21 21	24	30	79	0.209
			G3/4	20	4891 27 27	32	42	84	0.300
			G1	25	4891 34 34	38	42	102	0.519

4892 Non-Return Valve, Supply, Female BSPP Thread/Exhaust, Male BSPP Thread

	Stainless steel 316L, FKM		C	DN		F	G	L	kg
			G1/8	10	4892 10 10	17	22	56	0.100
			G1/4	10	4892 13 13	17	22	58	0.082
			G3/8	15	4892 17 17	22	30	75	0.191
			G1/2	15	4892 21 21	24	30	79	0.209
			G3/4	20	4892 27 27	32	42	84	0.300
			G1	25	4892 34 34	38	42	102	0.519

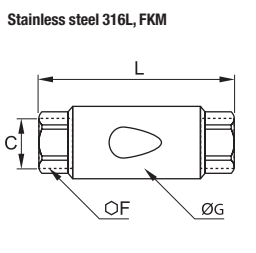
4895 Non-Return Valve, Female NPT Thread

	Stainless steel 316L, FKM		C	DN		F	G	L	kg
			NPT1/8	10	4895 11 11	17	22	50	0.083
			NPT1/4	10	4895 14 14	17	22	54	0.079
			NPT3/8	15	4895 18 18	22	30	67	0.197
			NPT1/2	15	4895 22 22	24	30	77	0.194